



***FAMILY
OWNED &
OPERATED
SINCE
2004***

about us

AVA Cabinetry recognizes that not all of our customers and their projects are the same. For this reason, we have launched several purchasing programs. Whether you are remodeling an apartment, adding our cabinetry to your own showroom, or remodeling your personal kitchen, we want to service your specific project's needs and give you the best pricing available. We have many options because when you purchase from us, you are purchasing factory direct!

AVA Cabinetry is also looking to form relationships with local professionals and businesses to grow and improve our services to customers. There are many opportunities available with us: From referring customers or helping them through the purchasing process, to assisting them with measuring, assembly, and installation. We may also be interested in joint marketing and recommending your business on our website. Feel free to email dealers@avacabinetry.com to receive more information about these opportunities.

contents

Company Information	04-05	Single Series	10
		-Key Largo White	10
Cabinet Features	06-09	-Colorado White Shaker	10
-Lumber Quality	07	-Carolina Hickory	10
-Finish	07	-Summit Shaker	10
-Corner Support	07		
-Assembly Method	08	Shaker Series	11
-Inside Finish	08	-White Shaker Elite	11
-Soft Close Hinge	09	-Grey Shaker Elite	11
-Soft Close Glides	09	-Navy Blue Shaker	11
-Life Time Warranty	09	-Shaker Espresso	11
		-Shaker Cinnamon	11
Wall Cabinet Specifications	14-16	York Series	11
		-York Driftwood Grey	11
Base Cabinet Specifications	16-17	-York Linen	11
		-York Chocolate	11
Tall Cabinet Specifications	17	-York Saddle	11
Accessory Cabinet Specifications	18-19	Charleston Series	12
		-Charleston Linen	12
Trim Specifications	19-20	-Charleston Saddle	12
		-Charleston Cherry	12
Vanity Cabinet Specifications	20-21	-Charleston Toffee	12
Vent Hood Specifications	21-23	Madison Series	12
		-Madison Linen	12
Cabinet Insert Specifications	23-24	-Madison Chocolate	12
		-Madison Toffee	12
Floating Shelf Specifications	24		
		Bristol Series	13
		-Bristol Linen	13
		-Bristol Antique	13
		-Bristol Chocolate	13

company **information**

1. Why buy from us?

We offer FREE door samples, FREE no obligation quotes, and FREE professional design services! With AVA Cabinetry, you'll receive excellent customer service before, during and after your order has been placed. We also offer a lowest price guarantee!

2. Where are you located?

Even though AVA Cabinetry is primarily online based, we have showroom locations that are open to the public in Adrian, MI, Kennesaw, GA, Largo, FL, and Murfreesboro, TN. We will be opening additional warehouses as well, so contact us to inquire about locations near you!

3. Are the cabinets shipped assembled?

Our cabinets are shipped Ready-to-Assemble (RTA). AVA Cabinetry also offers an assembly option for all orders. Contact us for more information regarding assembled cabinets.

4. Can I receive help designing my kitchen or bathroom?

Yes! We offer FREE professional design services. Please visit the 3D design tool on our website to be paired with one of our design specialists.

5. How do I place an order with you?

You may place an order yourself online at lilyanncabinets.com. Or, you can contact us at 800-551-1438 to speak with a designer/sales representative for direct assistance with ordering.

When/How will my order ship?

- All large orders will be shipped via LTA freight services. All small orders will be shipped via UPS or FedEx.
- All in-stock orders will follow a standard lead time of up to 14 business days, plus freight transit time. This lead time may be extended in the event of any revisions to the original order.
- Once your Order leaves our warehouse, you'll receive an email containing tracking information. The freight company will call 24 hrs in advance to schedule your delivery appointment. We recommend the buyer does not schedule installation until product is received.

cabinet features

AVA Cabinetry is one of the leading factory direct distributors of kitchen and bathroom cabinetry in the industry today. We have been selling our kitchen cabinets and bathroom vanities nationwide to customers since 2004, shipping out hundreds of projects a month, coast to coast. AVA Cabinetry is your one stop shop for all things cabinetry. With over 15 distinct finishes of cabinets to choose from, you're sure to find the unique look to suit your upcoming project.

Our goal as a company is to bring you a high quality product without the hefty price tag. Ready-to-Assemble (RTA) Cabinets will save you thousands of dollars, even in comparison to the big box stores. We offer our customers FREE samples, quotes, and professional layout design. AVA Cabinetry recognizes that not all of our customers and their projects are the same.

For this reason, we have launched several purchasing programs. Whether you are remodeling an apartment, adding our cabinetry to your own showroom, or remodeling your personal kitchen, we want to service you specific to your project needs and give you the best pricing available. We have many options because when you purchase from us, you are purchasing factory direct!



lumber quality

We believe quality cabinets begin with quality materials. We proudly source top-grade lumber for dependable quality assurance and long lasting beauty.



assembly method

Our dovetail cabinet construction process uniquely interlocks all components ensuring a strong cabinet that can stand the test of time. We also offer a metal clip assembly method that is standard to the RTA cabinet industry.



finish

To top off our solid wood cabinets, we apply an extensive 7- step finishing process to ensure their beauty lasts a lifetime. The doors and face-frames are hand finished with expert precision to create a smooth, premium quality finish.



soft-close

Our premium 6-way adjustable soft-closing hinges are included with most of AVA's cabinet styles. These compact soft-closing hinges ensure your cabinet doors shut smoothly and quietly, eliminating harsh slamming and preserving the integrity of the cabinet.



corner support

To ensure the highest structural integrity of our cabinets, we use wood and metal corner supports. These structural elements help to maintain squareness throughout the installation process and the lifetime of the cabinet.



soft close glides

An enhanced feature included with most of AVA Cabinetry is our premium drawer glides that soft-close with a small push. The full extension drawer glides also allow you to maximize storage and access the full depth of the drawer.

and more

Our solid wood drawer boxes are deeper than most competitors', which allows you to fit 25% more storage.

The latest in joint technology, our five-piece door and drawer construction assures less likely splitting of the joints.

Fully engineered door and drawer heads minimize expansion and contraction, reducing the risk of cracks in the finish.

Lily Ann Cabinets offers several different hand applied glaze color options.

We use a special clear plastic shelf clip to make sure your shelves snap in place and will not fall out. All of our shelves are also adjustable height so you can find the size you need.

Our cabinet box is made up of ½" 7-ply plywood on both sides, bottom and back panels.

All components lock together using our sliding dovetail design to ensure a strong, sturdy cabinet once assembled.

added value

Simple Modifications - We can increase or decrease the depth of any cabinet to any size, so you can create the perfect cabinet solution to suit your home.

Diverse Spec Book - AVA Cabinetry offers semi-custom sizing, a multitude of existing size offerings and a complete range of building products to suit every renovation project, regardless of size or price.

Expedited Shipping - With our national truck fleet of experienced drivers, we are able to provide quick nationwide shipping to all AVA Cabinetry customers. Depending on shipping location, some cabinet orders are shipped in as little as 1 week.

Experienced Staff - From our professional 3D designers to our dedicated sales team, AVA Cabinetry employees demonstrate exceptional product knowledge and are committed to providing an outstanding customer service experience.

lifetime warranty



At AVA Cabinetry, we stand behind our products. In the rare event of a defective cabinet, our products are backed by a Lifetime Warranty. We will stop at nothing to ensure your experience is positive from purchase to installation. For more information on our Lifetime Warranty, please visit www.avacabinetry.com/warranty

single series

KEY LARGO WHITE

Door Style: Full Overlay, Raised Panel (Full Engineered Door)
Box Construction: 1/2" Solid Plywood (Birch/Poplar)
Drawer Glide: Full Extension, Soft Close Under-Mount
Drawer: 5-Piece, Full Engineered Drawer Head (Matches Door)
Drawer Construction: 5/8" Solid Wood, Dovetail Construction
Hinge: Soft Close Adjustable
Interior Finish: Natural UV Coated
Cabinet Exterior: Matching Door Finish
Assembly Method: Metal Clip



COLORADO WHITE SHAKER

Door Style: Full Overlay, Flat Panel (Full Engineered Door)
Box Construction: 1/2" Solid Plywood (Birch/Poplar)
Drawer Glide: Full Extension, Soft Close Under-Mount
Drawer Head: 5-Piece, Full Engineered Drawer Head (Matches Door)
Drawer Construction: 5/8" Solid Wood, Dovetail Construction
Hinge: Soft Close Adjustable
Cabinet Interior: Natural UV Coated
Cabinet Exterior: Matching Door Finish
Assembly Method: Dovetail



SUMMIT SHAKER WHITE

Door Style: Partial Overlay, Flat Panel (Full Engineered Door)
Box Construction: 1/2" Solid Plywood (Birch/Poplar)
Drawer Glide: 3/4 Extension, Steel Epoxy Under-Mount
Drawer: 5-Piece, Full Engineered Drawer Head (Matches Door)
Drawer Construction: 5/8" Solid Wood, Dovetail Construction
Hinge: Soft Close Adjustable
Interior Finish: Natural Laminate
Cabinet Exterior: White Laminate
Assembly Method: Metal Clip



shaker series

Door Style: Full Overlay, Flat Panel (Full Engineered Door)

Box Construction: 1/2" Solid Plywood (Birch/Poplar)

Drawer Glide: Full Extension, Soft Close Under-Mount

Hinge: Soft Close Adjustable

Cabinet Interior: Natural UV Coated

Cabinet Exterior: Matching Door Finish

Drawer Head: 5-Piece, Full Engineered Drawer Head (Matches Door)

Drawer Construction: 5/8" Solid Wood, Dovetail Construction

Assembly Method: Dovetail

SHAKER CINNAMON



NAVY BLUE SHAKER

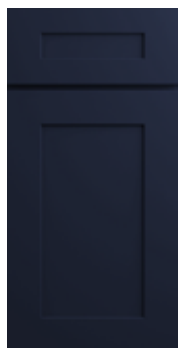

WHITE SHAKER ELITE

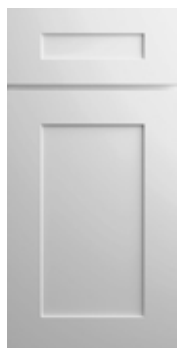

GREY SHAKER ELITE

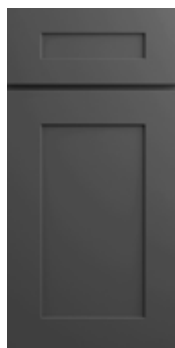

SHAKER ESPRESSO



york series

Door Style: Full Overlay, Flat Panel with Glaze (Engineered Center Panel)

Box Construction: 1/2" Solid Plywood (Birch/Poplar)

Drawer Glide: Full Extension, Soft Close Under-Mount

Hinge: Soft Close Adjustable

Cabinet Interior: Natural UV Coated

Cabinet Exterior: Matching Door Finish

Drawer Head: 5-Piece, Engineered Center Panel (Matches Door)

Drawer Construction: 5/8" Solid Wood, Dovetail Construction

Assembly Method: Dovetail

YORK DRIFTWOOD GREY



YORK SADDLE



YORK LINEN



charleston series

Door Style: Solid Wood Full Overlay, Raised Panel with Glazing
Box Construction: 1/2" Solid Plywood (Birch/Poplar)
Drawer Glide: Full Extension, Soft Close Under-Mount

Hinge: Soft Close Adjustable
Cabinet Interior: Natural UV Coated
Cabinet Exterior: Matching Door Finish

Drawer Head: Solid Wood, 5-Piece (Matches Door)
Drawer Construction: 5/8" Solid Wood, Dovetail Construction
Assembly Method: Dovetail

CHARLESTON TOFFEE



CHARLESTON SADDLE



CHARLESTON LINEN



CHARLESTON CHERRY



madison series

Door Style: Full Overlay, Raised Panel with Glazing (Engineered Center Panel)
Box Construction: 1/2" Solid Plywood (Birch/Poplar)
Drawer Glide: Side-Mount Epoxy

Hinge: 6-way Adjustable, Concealed Cup Hinge
Cabinet Interior: Natural UV Coated
Cabinet Exterior: Matching Door Finish

Drawer Head: 5-Piece, Engineered Center Panel (Matches Door)
Drawer Construction: 5/8" Solid Wood, Dovetail Construction
Assembly Method: Metal Clip

MADISON CHOCOLATE



MADISON TOFFEE



bristol series

Door Style: Solid Wood Full Overlay, Raised Panel with Glazing

Box Construction: 1/2" Solid Plywood (Birch/Poplar)

Drawer Glide: Full Extension, Soft Close Under-Mount

Hinge: Soft Close Adjustable

Cabinet Interior: Natural UV Coated

Cabinet Exterior: Matching Door Finish

Drawer Head: Solid Wood, 5-Piece (Matches Door)

Drawer Construction: 5/8" Solid Wood, Dovetail Construction

Assembly Method: Dovetail

BRISTOL LINEN



wall cabinet specification

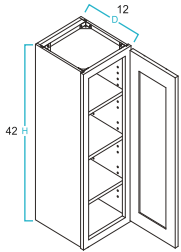

High Single Door Wall Cabinets							
SKU	Cabinet Box			Cabinet Doors			
	W	H	D	W	H	D	
W0942	9	42	12	8 1/2	41	7/8	
W1242	12	42	12	11 1/2	41	7/8	
W1542	15	42	12	14 1/2	41	7/8	
W1842	18	42	12	17 1/2	41	7/8	
W2142	21	42	12	20 1/2	41	7/8	

*All single door cabinets may be left or right swing.

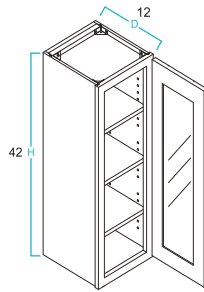

SKU	Cabinet Box			Cabinet Doors		
	W	H	D	W	H	D
WM1542GDFI	15	42	12	14 1/2	41	7/8
WM1842GDFI	18	42	12	17 1/2	41	7/8

*All single door cabinets may be left or right swing.
Finished interior, glass included.
Mullion bars on Charleston Series only.
(excluding Charleston Antique White and Charleston Linen)

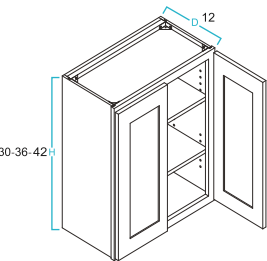

30/36/42" High Double Door Wall Cabinets							
SKU	Cabinet Box			Cabinet Doors			
	W	H	D	W	H	D	
W2430	24	30	12	11 3/4	29	7/8	
W2730	27	30	12	13 1/4	29	7/8	
W3030	30	30	12	14 5/8	29	7/8	
W3330	33	30	12	16 1/4	29	7/8	
W3630	36	30	12	17 3/4	29	7/8	
W3930	39	30	12	19	29	7/8	
W2436	24	36	12	11 3/4	35	7/8	
W2736	27	36	12	13 1/4	35	7/8	
W3036	30	36	12	14 5/8	35	7/8	
W3336	33	36	12	16 1/4	35	7/8	
W3636	36	36	12	17 3/4	35	7/8	
W3936	39	36	12	19	35	7/8	
W2442	24	42	12	11 3/4	41	7/8	
W2742	27	42	12	13 1/4	41	7/8	
W3042	30	42	12	14 5/8	41	7/8	
W3342	33	42	12	16 1/4	41	7/8	
W3642	36	42	12	17 3/4	41	7/8	
W3942	39	42	12	19	41	7/8	

*39" only has center stile.

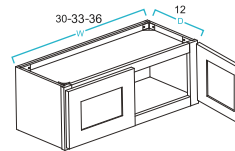

*24" tall cabinets have one shelf.

24" Wide Double Door Bridge Wall Cabinets							
SKU	Cabinet Box			Cabinet Doors			
	W	H	D	W	H	D	
W2415	24	15	12	11 3/4	14	7/8	
W2418	24	18	12	11 3/4	17	7/8	
W2424	24	24	12	11 3/4	23	7/8	

*24" tall cabinets have one shelf.

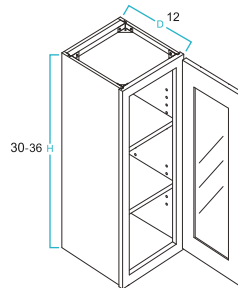

30/36" High Single Glass Door Wall Cabinets							
SKU	Cabinet Box			Cabinet Doors			
	W	H	D	W	H	D	
WM1530GDFI	15	30	12	14 1/2	29	7/8	
WM1830GDFI	18	30	12	17 1/2	29	7/8	
WM1536GDFI	15	36	12	14 1/2	35	7/8	
WM1836GDFI	18	36	12	17 1/2	35	7/8	

*All single door cabinets may be left or right swing.
Finished interior, glass included.
Mullion bars on Charleston Series only.
(excluding Charleston Antique White and Charleston Linen)

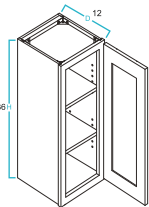

30/36" High Single Door Wall Cabinets							
SKU	Cabinet Box			Cabinet Doors			
	W	H	D	W	H	D	
W0930	9	30	12	8 1/2	29	7/8	
W1230	12	30	12	11 1/2	29	7/8	
W1530	15	30	12	14 1/2	29	7/8	
W1830	18	30	12	17 1/2	29	7/8	
W2130	21	30	12	20 1/2	29	7/8	
W0936	9	36	12	8 1/2	35	7/8	
W1236	12	36	12	11 1/2	35	7/8	
W1536	15	36	12	14 1/2	35	7/8	
W1836	18	36	12	17 1/2	35	7/8	
W2136	21	36	12	20 1/2	35	7/8	

*All single door cabinets may be left or right swing.

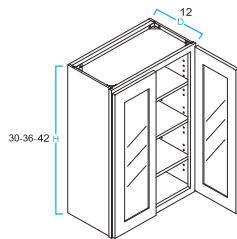

*Finished interior, glass included.
Mullion bars on Charleston Series only.
(excluding Charleston Antique White and Charleston Linen)

30/36/42" High Double Glass Door Wall Cabinets							
SKU	Cabinet Box			Cabinet Doors			
	W	H	D	W	H	D	
W2430	24	30	12	11 3/4	29	7/8	
W3030	30	30	12	14 5/8	29	7/8	
W3630	36	30	12	17 3/4	29	7/8	
W2436	24	36	12	11 3/4	35	7/8	
W3036	30	36	12	14 5/8	35	7/8	
W3636	36	36	12	17 3/4	35	7/8	
W2442	24	42	12	11 3/4	41	7/8	
W3042	30	42	12	14 5/8	41	7/8	
W3642	36	42	12	17 3/4	41	7/8	

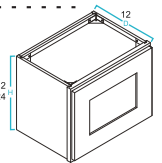

12/24" High Single Door Bridge Wall Cabinets							
SKU	Cabinet Box			Cabinet Doors			
	W	H	D	W	H	D	
W1812	18	12	12	17 1/2	11	7/8	
W2112	21	12	12	20 1/2	11	7/8	
W2124	21	24	12	20 1/2	23	7/8	

*All single door cabinets can be left or right swing.
24" tall cabinets have one shelf.

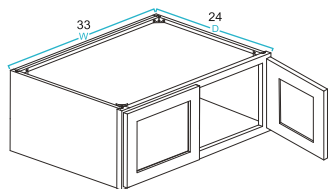

33" Wide Refrigerator Wall Cabinets							
SKU	Cabinet Box			Cabinet Doors			
	W	H	D	W	H	D	
W331224	33	12	24	16 1/4	11	7/8	
W331824	33	18	24	16 1/4	17	7/8	
W332424	33	24	24	16 1/4	23	7/8	

*24" tall cabinets have one shelf.

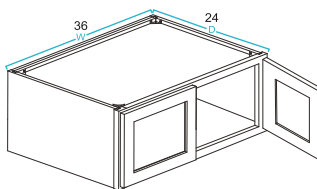

36" Wide Refrigerator Wall Cabinets							
SKU	Cabinet Box			Cabinet Doors			
	W	H	D	W	H	D	
W361224	36	12	24	17 3/4	11	7/8	
W361524	36	15	24	17 3/4	14	7/8	
W361824	36	18	24	17 3/4	17	7/8	
W362424	36	24	24	17 3/4	23	7/8	

*24" tall cabinets have one shelf.

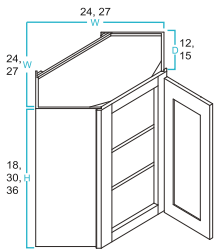

18 - 36" Diagonal Corner Wall Cabinets							
SKU	Cabinet Box			Cabinet Doors			
	W	H	D	W	H	D	
WDC2418	24	18	12	15	17	7/8	
WDC2430	24	30	12	15	29	7/8	
WDC2436	24	36	12	15	35	7/8	
WDC273615	27	36	15	15	35	7/8	

*All single door cabinets may be left or right swing. WDC2418 has no shelf.

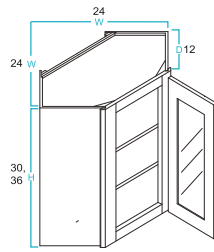

30 - 36" Diagonal Corner Glass Wall Cabinets							
SKU	Cabinet Box			Cabinet Doors			
	W	H	D	W	H	D	
WMDC2430GDFI	24	30	12	15	39	7/8	
WMDC2436GDFI	24	36	12	15	35	7/8	

*All single door cabinets may be left or right swing. Finished interior, glass included. Mullion bars on Charleston Series only. (excluding Charleston Antique White and Charleston Linen)

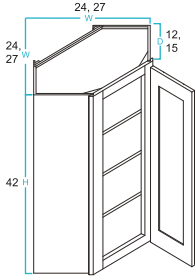

42" Diagonal Corner Wall Cabinets							
SKU	Cabinet Box			Cabinet Doors			
	W	H	D	W	H	D	
WDC2442	24	42	12	15	41	7/8	
WDC274215	27	42	12	15	41	7/8	

*All single door cabinets may be left or right swing.

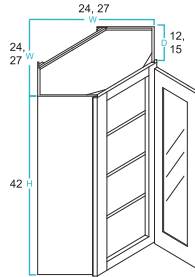

42" Diagonal Corner Glass Wall Cabinets							
SKU	Cabinet Box			Cabinet Doors			
	W	H	D	W	H	D	
WMDC2442GDFI	24	30	12	15	39	7/8	
WMDC274215GDFI	24	36	12	15	35	7/8	

*All single door cabinets may be left or right swing. Finished interior, glass included. Mullion bars on Charleston Series only. (excluding Charleston Antique White and Charleston Linen)

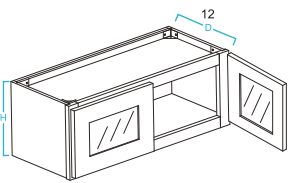

12" High Double Door Glass Wall Cabinet							
SKU	Cabinet Box			Cabinet Doors			
	W	H	D	W	H	D	
W2412BGFI	24	12	12	11 3/4	11	7/8	
W2712BGFI	27	12	12	13 3/4	11	7/8	
W3012BGFI	30	12	12	14 1/4	11	7/8	
W3312BGFI	33	12	12	16 1/4	11	7/8	
W3612BGFI	36	12	12	17 3/4	11	7/8	

*Finished interior, glass included.

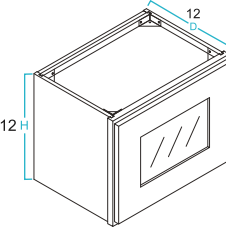

12" High Single Door Glass Wall Cabinet							
SKU	Cabinet Box			Cabinet Doors			
	W	H	D	W	H	D	
W1212BGFI	12	12	12	11 1/2	11	7/8	
W1512BGFI	15	12	12	14 1/2	11	7/8	
W1812BGFI	18	12	12	17 1/2	11	7/8	
W2112BGFI	21	12	12	20 1/2	11	7/8	

*All single door cabinets may be left or right swing. Finished interior, glass included.

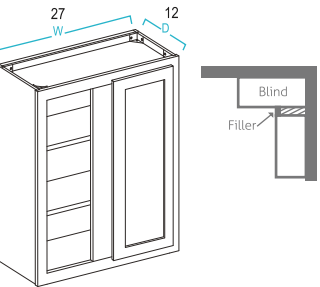

Blind Corner Wall Cabinets							
SKU	Cabinet Box			Cabinet Doors			
	W	H	D	W	H	D	
BLW2730	27	30	12	11 1/2	29	7/8	
BLW2736	27	36	12	11 1/2	35	7/8	
BLW2742	27	42	12	11 1/2	41	7/8	

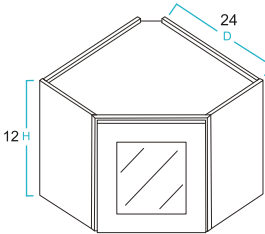

12" High Single Door Glass Corner Cabinet							
SKU	Cabinet Box			Cabinet Doors			
	W	H	D	W	H	D	
WDC2412BGFI	24	12	12	11	15	7/8	

*All single door cabinets may be left or right swing. Finished interior, glass included.

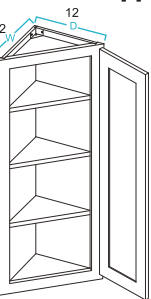

High Angle Wall Cabinets							
SKU	Cabinet Box			Cabinet Doors			
	W	H	D	W	H	D	
AW1230	12	30	12	15 1/4	29	7/8	
AW1236	12	36	12	15 1/4	35	7/8	
AW1242	12	42	12	15 1/4	41	7/8	

*All single door cabinets can be left or right swing.

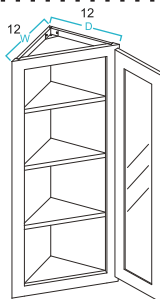

High Angle Glass Wall Cabinets							
SKU	Cabinet Box			Cabinet Doors			
	W	H	D	W	H	D	
WMDAW1230	12	30	12	15 1/4	29	7/8	
WMDAW1236	12	36	12	15 1/4	35	7/8	
WMDAW1242	12	42	12	15 1/4	41	7/8	

*All single door cabinets can be left or right swing.

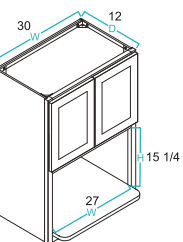

30" Wide Microwave Oven Cabinets							
SKU	Cabinet Box			Cabinet Doors			
	W	H	D	W	H	D	
MO3030	30	30	12	14 5/8	10 1/2	7/8	
MO3036	30	36	12	14 5/8	16 1/2	7/8	
MO3042	30	42	12	14 5/8	22 1/2	7/8	

*Opening dimension is 27" x 15 1/4". Shelf is 18" deep.

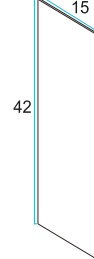
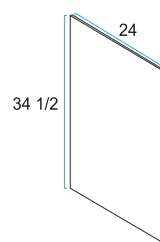

Base and Wall Skins			
SKU	Dimensions		
	W	H	D
BS24	24	34 1/2	1/4
WS24	15	42	1/4

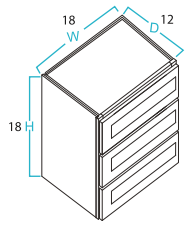

18" Wide/High Wall Drawer Cabinet									
SKU	Cabinet Box			Drawer Head			Drawer Boxes		
	W	H	D	W	H	D	W	H	D
WD1818	18	18	12	17 1/2	5 3/8	7/8	14	3	10

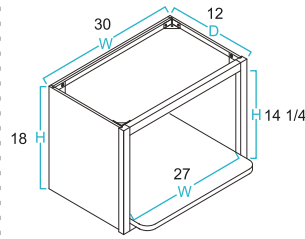

30" Wide Wall Microwave Cabinet						
SKU	Cabinet Box			Cabinet Doors		
	W	H	D	W	H	D
MS3018	30	18	12	N/A	N/A	N/A

*Opening dimension is 27" x 14 1/4".
Shelf is 18" deep.

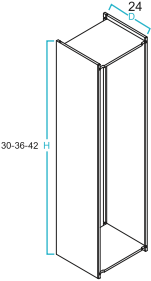

Depth Wall Modification Kits	
WKIT30	
WKIT36	
WKIT42	

*Must be modified by Lily Ann
Natural finished interior.

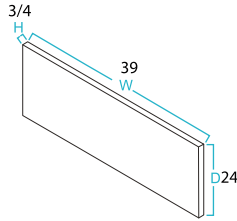

24" Shelf Kit
SKIT24

*Comes with three natural finished shelves.



15" Depth Wall Modification Kits	
WKIT3015	
WKIT3615	
WKIT4215	

*Used to increase all standard wall cabinet depth.
Shelves included are 15" deep.
Natural finished interior.

base cabinet specification

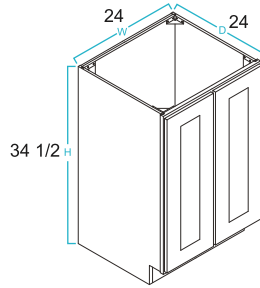

24" Full Height Double Door Base Cabinet						
SKU	Cabinet Box			Cabinet Doors		
	W	H	D	W	H	D
B24FHD	24	34 1/2	24	11 3/4	29 1/4	7/8

*One adjustable shelf.

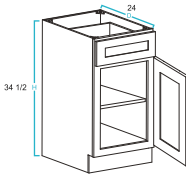

12 - 21" Wide Single Door/Single Drawer Base Cabinets												
SKU	Cabinet Box			Cabinet Doors			Drawer Head			Drawer Box		
	W	H	D	W	H	D	W	H	D	W	H	D
B12	12	34 1/2	24	11 1/2	22	7/8	11 1/2	6 3/4	7/8	8 1/2	4	21
B15	15	34 1/2	24	14 1/2	22	7/8	14 1/2	6 3/4	7/8	11 1/2	4	21
B18	18	34 1/2	24	17 1/2	22	7/8	17 1/2	6 3/4	7/8	14 1/2	4	21
B21	21	34 1/2	24	20 1/2	22	7/8	20 1/2	6 3/4	7/8	17 1/2	4	21

*All single door cabinets may be left or right swing.
One adjustable shelf.

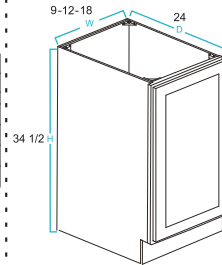

9 - 18" Full Height Single Door Base Cabinets						
SKU	Cabinet Box			Cabinet Doors		
	W	H	D	W	H	D
B9FHD	9	34 1/2	24	8 1/2	29 1/4	7/8
B12FHD	12	34 1/2	24	11 1/2	29 1/4	7/8
B18FHD	18	34 1/2	24	17 1/2	29 1/4	7/8

*All single door cabinets may be left or right swing.
One adjustable shelf.

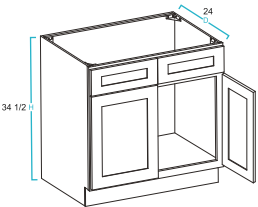

36 - 42" Wide Double Door Sink Base Cabinets									
SKU	Cabinet Box			Cabinet Doors			Drawer Head		
	W	H	D	W	H	D	W	H	D
SB36	36	34 1/2	24	17 3/4	22	7/8	17 3/4	6 3/4	7/8
SB42	42	34 1/2	24	20 1/2	22	7/8	20 1/2	6 3/4	7/8

*SB42 has center stile

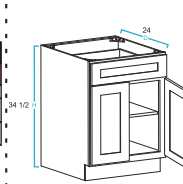

24 - 30" Wide Double Door/Single Drawer Base Cabinets												
SKU	Cabinet Box			Cabinet Doors			Drawer Head			Drawer Box		
	W	H	D	W	H	D	W	H	D	W	H	D
B24	24	34 1/2	24	11 3/4	22	7/8	23 1/2	6 3/4	7/8	20 1/2	4	21
B27	27	34 1/2	24	13 3/4	22	7/8	26 1/2	6 3/4	7/8	23 1/2	4	21
B30	30	34 1/2	24	14 5/8	22	7/8	29 1/2	6 3/4	7/8	26	4	21

*Madison Series B30 cabinets are single drawer, all other series B30 cabinets are double drawer.
One adjustable shelf.

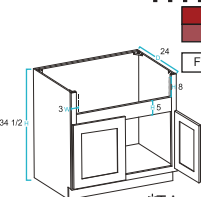

36" Wide Farm Sink Base Cabinet						
SKU	Cabinet Box			Cabinet Doors		
	W	H	D	W	H	D
FSB36	36	34 1/2	24	17 3/4	17 3/4	7/8

*Trimable to accommodate 30-36" wide, 8-11 1/2" tall farm sinks.
Additional bracing may be required.

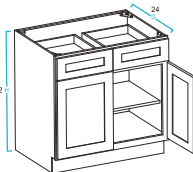

30 - 42" Double Door/Double Drawer Base Cabinets												
SKU	Cabinet Box			Cabinet Doors			Drawer Head			Drawer Box		
	W	H	D	W	H	D	W	H	D	W	H	D
B30	30	34 1/2	24	14 5/8	22	7/8	14 5/8	6 3/4	7/8	11 5/8	4	21
B33	33	34 1/2	24	16 1/4	22	7/8	16 1/4	6 3/4	7/8	13 1/4	4	21
B36	36	34 1/2	24	17 3/4	22	7/8	17 3/4	6 3/4	7/8	14 3/4	4	21
B39	39	34 1/2	24	19	22	7/8	19 1/8	6 3/4	7/8	16	4	21
B42	42	34 1/2	24	20 1/2	22	7/8	20 1/2	6 3/4	7/8	17 1/2	4	21

*B39 and B42 have center stile.
One adjustable shelf.

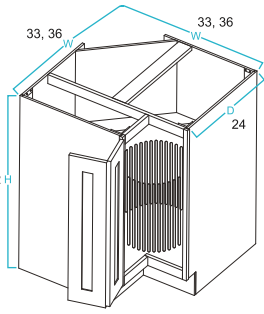

33 - 36" Lazy Susan Base Cabinets							
SKU	Cabinet Box			Cabinet Doors			
	W	H	D	W	H	D	D
LS33	33	34 1/2	24	7 3/4	29 1/4	7/8	
LS36	36	34 1/2	24	10 3/4	29 1/4	7/8	

*Comes with shelf and polymer carousel kit.

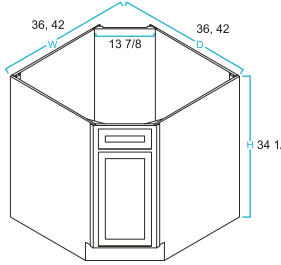

36 - 42" Corner Sink Bases								
SKU	Cabinet Box			Cabinet Doors			Drawer Head	
	W	H	D	W	H	D	W	H
CSB36	36	34 1/2	36	15	22	7/8	15	6 3/4
CSB42	42	34 1/2	42	23 1/2	22	7/8	23 1/2	6 3/4

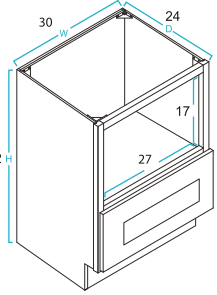

30" Microwave Base Cabinets								
SKU	Cabinet Box			Drawer Head		Drawer Box		
	W	H	D	W	H	D	W	H
MB30	30	34 1/2	24	29 1/2	10 3/4	21	26 1/2	8

*Fillers can be used to accommodate smaller microwaves.

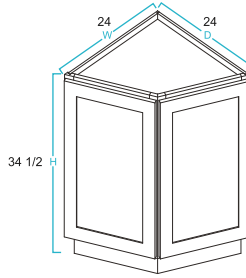

24" Depth Angle Base Cabinet						
SKU	Cabinet Box			Cabinet Doors		
	W	H	D	W	H	D
AB24	24	34 1/2	24	17 7/8	29 1/4	7/8

24 - 36" Wide Two Drawer Base Cabinets								
SKU	Cabinet Box			Drawer Head		Drawer Box		
	W	H	D	W	H	D	W	H
DB24-2	25	34 1/2	24	23 1/2	14 3/8	7/8	20 1/2	11
DB36-2	36	34 1/2	24	35 1/2	14 3/8	7/8	32 1/2	11

*Drawer heads are the same size.

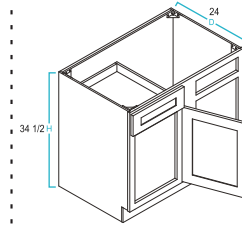
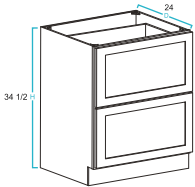

36/39" - 42/45" Wide Blind Base Corner Cabinets											
SKU	Cabinet Box			Cabinet Doors			Drawer Head		Drawer Box		
	W	H	D	W	H	D	W	H	D	D	
BLB36/39L	36	34 1/2	24	11 1/2	22	7/8	11 1/2	6 3/4	7/8	8 1/2	
BLB36/39R	36	34 1/2	24	11 1/2	22	7/8	11 1/2	6 3/4	7/8	8 1/2	
BLB42/45L	42	34 1/2	24	17 1/2	27	7/8	17 1/2	6 3/4	7/8	14 1/2	
BLB42/45R	42	34 1/2	24	17 1/2	27	7/8	17 1/2	6 3/4	7/8	14 1/2	

*All blind base cabinets must be pulled 3".
L/R refers to which side the blind is on.
Blind can be on the left or right.

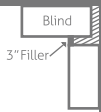

*Bottom drawer heads are same size.

12 - 36" Wide Three Drawer Base Cabinets							
SKU	Bottom Drawer Heads			Bottom Drawer Boxes			
	W	H	D	W	H	D	D
DB12-3	11 1/2	10 3/4	7/8	8 1/2	7 1/2	21	
DB15-3	14 1/2	10 3/4	7/8	11 1/2	7 1/2	21	
DB18-3	17 1/2	10 3/4	7/8	14 1/2	7 1/2	21	
DB21-3	20 1/2	10 3/4	7/8	17 1/2	7 1/2	21	
DB24-3	23 1/2	10 3/4	7/8	20 1/2	7 1/2	21	
DB30-3	29 1/2	10 3/4	7/8	26 1/2	7 1/2	21	
DB36-3	35 1/2	10 3/4	7/8	32 1/2	7 1/2	21	

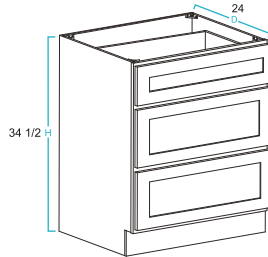

12 - 36" Wide Three Drawer Base Cabinets									
SKU	Cabinet Box			Top Drawer Head			Top Drawer Box		
	W	H	D	W	H	D	W	H	D
DB12-3	12	34 1/2	24	11 1/2	6 3/4	7/8	8 1/2	4	21
DB15-3	15	34 1/2	24	14 1/2	6 3/4	7/8	11 1/2	4	21
DB18-3	18	34 1/2	24	17 1/2	6 3/4	7/8	14 1/2	4	21
DB21-3	21	34 1/2	24	20 1/2	6 3/4	7/8	17 1/2	4	21
DB24-3	24	34 1/2	24	23 1/2	6 3/4	7/8	20 1/2	4	21
DB30-3	30	34 1/2	24	29 1/2	6 3/4	7/8	26 1/2	4	21
DB36-3	36	34 1/2	24	35 1/2	6 3/4	7/8	32 1/2	4	21

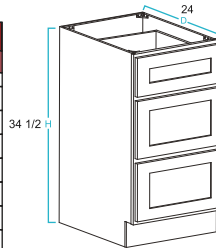

tall cabinet specification

18" Wide Utility Cabinets						
SKU	Cabinet Box			Top Doors		
	W	H	D	W	H	D
U188424	18	84	24	17 1/2	29	7/8
U189024	18	90	24	17 1/2	35	7/8
U189624	18	96	24	17 1/2	41	7/8

*Three adjustable shelves.

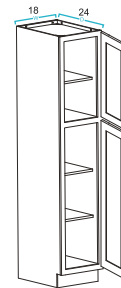

24/30" Wide Utility Cabinets						
SKU	Cabinet Box			Top Doors		
	W	H	D	W	H	D
U248424	24	84	24	11 3/4	29	7/8
U249024	24	90	24	11 3/4	35	7/8
U249624	24	96	24	11 3/4	41	7/8
U308424	30	84	24	14 5/8	29	7/8
U309024	30	90	24	14 5/8	35	7/8
U309624	30	96	24	14 5/8	41	7/8

*Three adjustable shelves.

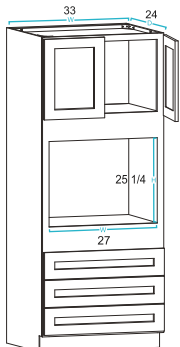
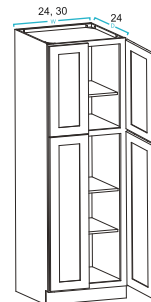

33" Wide Universal Oven Cabinets											
SKU	Cabinet Box			Cabinet Doors			Drawer Head		Drawer Box		
	W	H	D	W	H	D	W	H	W	H	D
O338424	33	84	24	16 1/4	11 1/2	7/8	32 1/2	8	7/8	29 1/2	5 1/8
O339024	33	90	24	16 1/4	17 1/2	7/8	32 1/2	8	7/8	29 1/2	5 1/8
O339624	33	96	24	16 1/4	23 1/2	7/8	32 1/2	8	7/8	29 1/2	5 1/8

*Opening is 27" x 25 1/4".
Drawers can be removed to accommodate larger ovens.
Fillers can be used to accommodate smaller ovens.

accessory cabinet specification

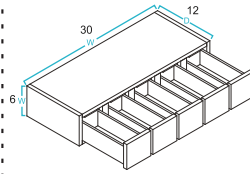

30" Wide Wall Spice Drawer Cabinet										
SKU	Cabinet Box			Drawer Heads			Drawer Boxes			
	W	H	D	W	H	D	W	H	D	D
WSD630	30	6	12	5 3/4	5 1/2	7/8	4 3/4	3 5/8	10	

*Friction drawers, non soft close, no glides.

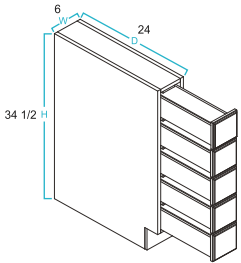

6" Wide Base Spice Drawer Cabinet										
SKU	Cabinet Box			Drawer Heads			Drawer Boxes			
	W	H	D	W	H	D	W	H	D	D
BSDC6	6	34 1/2	24	5 1/2	5 3/4	7/8	4 1/4	3 5/8	21	

*Friction drawers, non soft close, no glides.
Non finished sides.

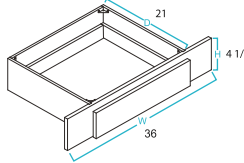

30 - 36" Wide Desk Drawer										
SKU	Cabinet Box			Drawer Head			Drawer Boxes			
	W	H	D	W	H	D	W	H	D	D
DSK30/36	36	4 1/2	21	29 1/2	3 3/4	7/8	26 1/2	2 1/8	21	

*Can be trimmed from 30-36" wide.

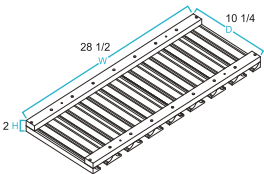

30" Wide Plate Rack Cabinet				
SKU	Dimensions			
	W	H	D	
SGH30	28 1/2	2	10 1/4	

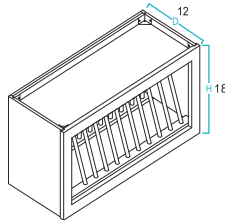

30" Wide Plate Rack Cabinet				
SKU	Dimensions			
	W	H	D	
W3018PR	30	18	12	

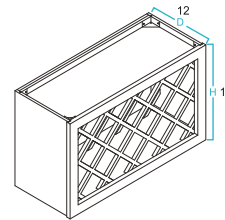

30" Wide Wine Rack Cabinet				
SKU	Dimensions			
	W	H	D	
W3018WR	30	18	12	

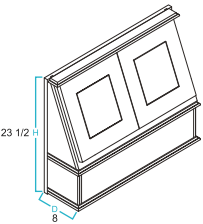

30 - 36" Wide Range Hood Cabinets				
SKU	Cabinet Box			
	W	H	D	
RGH30	30	23 1/2	8	
RGH36	36	23 1/2	8	

*Mounts between two cabinets.
Must use Convertible hood fan with T-Shape Hood Liner

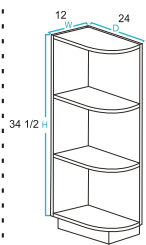

12" Wide Base End Shelf				
SKU	Cabinet Box			
	W	H	D	
BES24-L	12	34 1/2	24	
BES24-R	12	34 1/2	24	

*Can be left or right.

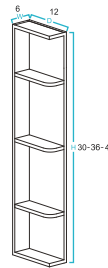

30 - 42" Tall Wall End Shelves				
SKU	Cabinet Box			
	W	H	D	
WESR630	6	30	12	
WESR636	6	36	12	
WESR642	6	42	12	

*Can be left or right.

Decorative Bun Feet - Classic/Fluted

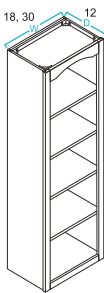
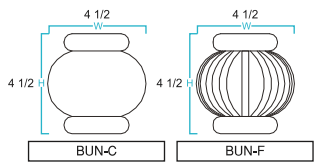

18 - 30" Wide Book Case Cabinets				
SKU	Cabinet Box			
	W	H	D	
BC1848	18	48	12	
BC1860	18	48	12	
BC3048	30	60	12	
BC3060	30	60	12	

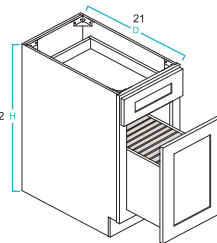

18" Wide Drawer File Base Cabinet											
SKU	Cabinet Box			Top Drawer Head			Top Drawer Box				
	W	H	D	W	H	D	W	H	D	D	
DFB18-2	18	29 1/2	21	17 1/2	6 3/4	7/8	14 1/2	4	18		
SKU	Bottom Drawer Heads			Bottom Drawer Boxes							
	W	H	D	W	H	D	W	H	D	D	
DFB18-2	17 1/2	17	7/8	14 1/2	13 3/4	18					

*Cabinets is 29 1/2" tall.
Filing cabinet separators not included.

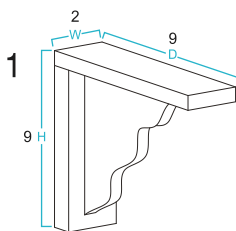
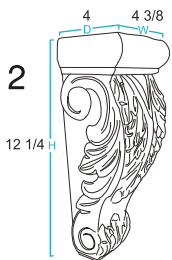

Decorative Corbels				
SKU	Dimensions			
	W	H	D	
CB9	2	9	9	
SKU	Dimensions			
	W	H	D	
CBT	4 3/8	12 1/4	4	

*Check availability

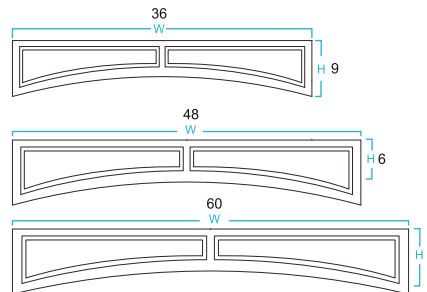

36 - 60" Wide Arched Valances	
VA36	
VA48	
VA60	

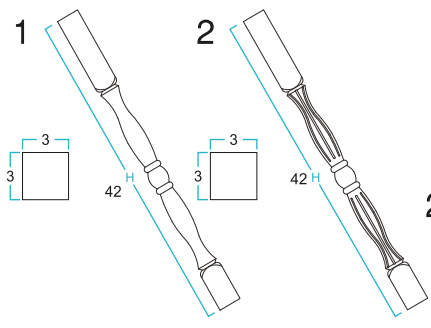

42" Tall Decorative Leg Posts - Classic/Fluted

1	SKU	Dimensions		
		W	H	D
	PST-C	3	42	3

2	SKU	Dimensions		
		W	H	D
	PST-F	3	42	3

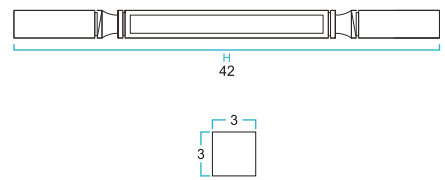

42" Tall Decorative Posts - Shaker

1	SKU	Dimensions		
		W	H	D
	PST-S	3	42	3

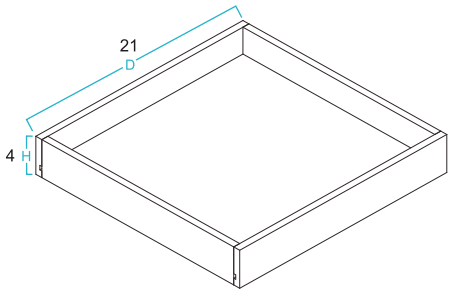

15 - 36" Roll Out Shelf Trays

SKU	Dimensions			
	W	H	D	
RS15	11	4	21	
RS18	14	4	21	
RS21	17	4	21	
RS24	20	4	21	
RS27	23	4	21	
RS30	26	4	21	
RS33	29	4	21	
RS36	32	4	21	

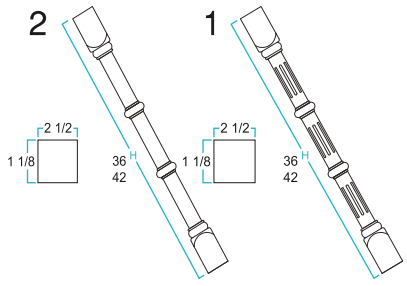

36 - 42" Tall Split Post Overlay Fillers - Classic/Fluted

1	SKU	Dimensions		
		W	H	D
	SPST36-F	2 1/2	36	1 1/8
	SPST42-F	2 1/2	42	1 1/8

2	SKU	Dimensions		
		W	H	D
	SPST36-C	2 1/2	36	1 1/8
	SPST42-C	2 1/2	42	1 1/8

Scribe Molding SM8 *96" Length

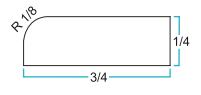

Batten Molding BM8 *96" Length

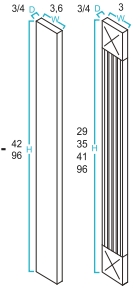
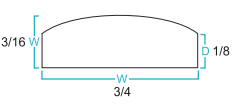

3 - 6" Wide Fillers - Regular/Fluted

SKU	Dimensions			
	W	H	D	
F342	3	42	3/4	
F642	6	42	3/4	
F396	3	96	3/4	
F696	6	96	3/4	
FF330	3	29	3/4	
FF336	3	35	3/4	
FF342	3	41	3/4	
FF396	3	95	3/4	

**"FF" are fluted filler sizes.

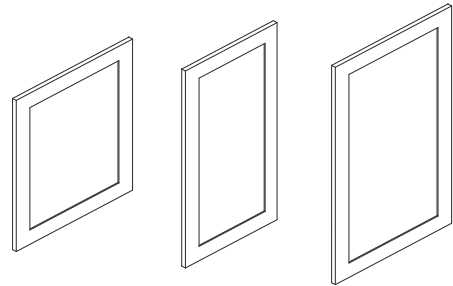

Decorative Door Panels

SKU	Dimensions			
	W	H	D	
BDD24	23 1/2	30	3/4	
WDD630	5 1/2	29	3/4	
WDD30	11 1/2	29	3/4	
WDD36	11 1/2	35	3/4	
WDD42	11 1/2	41	3/4	
UDD2430	23 1/2	29	7/8	
UDD2436	23 1/2	35	7/8	
UDD2442	23 1/2	41	7/8	
UDD2449	23 1/2	49 1/4	7/8	

trim specification

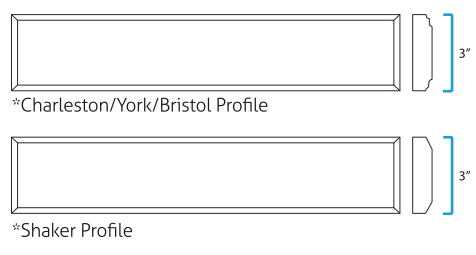

3" Wide Overlay Wall Fillers

SKU	Dimensions		
	W	H	D
OWF330	3	29	3/4
OWF336	3	35	3/4
OWF342	3	41	3/4
OWF384	3	83	3/4
OWF390	3	89	3/4
OWF396	3	95	3/4

Toe Kick TK8 *96" Length

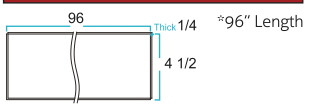

Angle Outside Corner Molding AOCM8 *96" Length

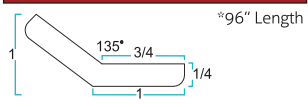

Outside Corner Molding OCM8 *96" Length

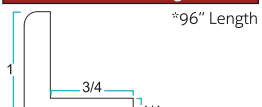

Inside Corner Molding ICM8 *96" Length

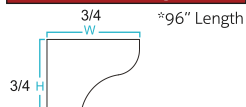

Quarter Round Molding QRM8 *96" Length



Light Rail Molding/Angle Light Rail Molding LRM8/ALRM8 *96" Length

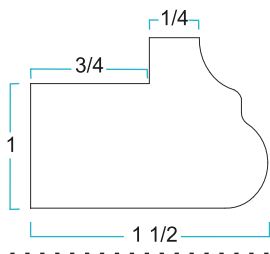

LRM8
*Charleston
York
Bristol

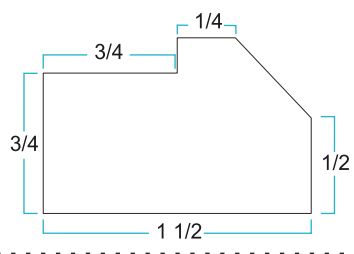

ALRM8
*Shaker

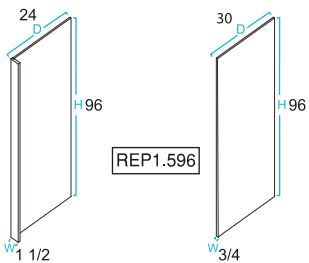
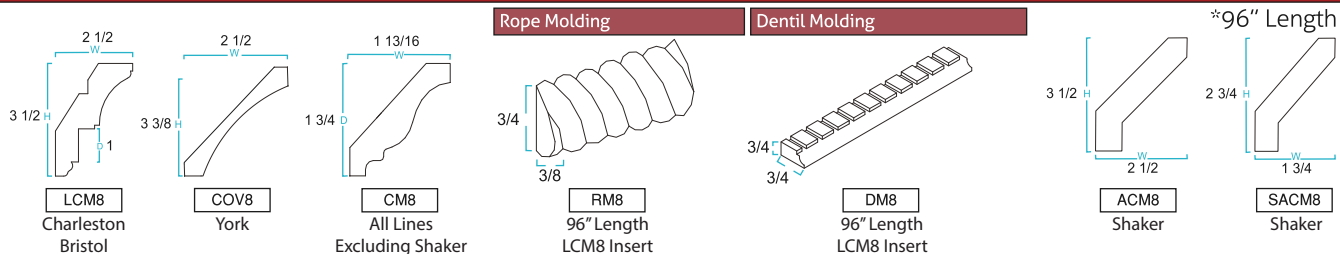

Refrigerator End Panels		Dimensions		
SKU		W	H	D
REP1.596		1.5	96	24
UREP96		3/4	96	30

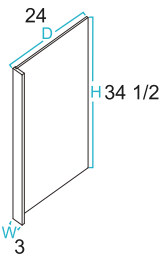

Dishwasher Return Panel		Dimensions		
SKU		W	H	D
DWR3		3	34 1/2	24

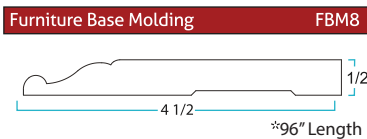

Touch Up Kit

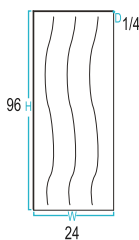
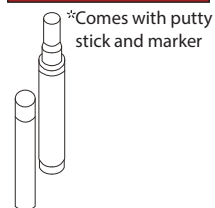

UPLY2496

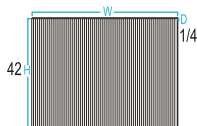

BBPLY4248
BBPLY4296

Finished Plywood Panels

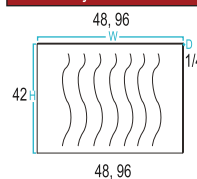

PLY4248
PLY4296

SKU	Dimensions		
	W	H	D
PLY4248	48	42	1/4
PLY4296	96	42	1/4
BBPLY4248	48	42	1/4
BBPLY4296	96	42	1/4
UPLY2496	24	96	1/4

vanity cabinet specification

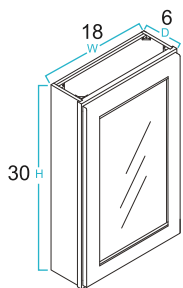

18 - 24" Wide Medicine Cabinets

SKU	Dimensions		
	W	H	D
MC1830	18	30	6

*Glass not included.

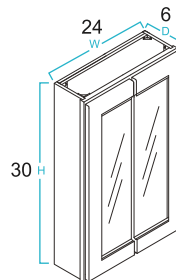

SKU	Dimensions		
	W	H	D
MC2430	24	30	6

*Glass not included.

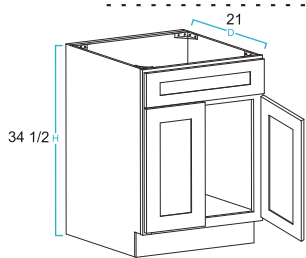

*Cabinet box is 21" deep.

L/R refers to which side drawers are on.

24 - 36" Wide Vanity Sink Base Cabinets

SKU	Cabinet Box			Cabinet Doors			Drawer Head		
	W	H	D	W	H	D	W	H	D
V2421	24	34 1/2	21	11 3/4	22	7/8	23 1/2	6 3/4	7/8
V2721	27	34 1/2	21	13 3/4	22	7/8	26 1/2	6 3/4	7/8
V3021	30	34 1/2	21	14 5/8	22	7/8	29 1/2	6 3/4	7/8
V3621	36	34 1/2	21	17 3/4	22	7/8	35 1/2	6 3/4	7/8

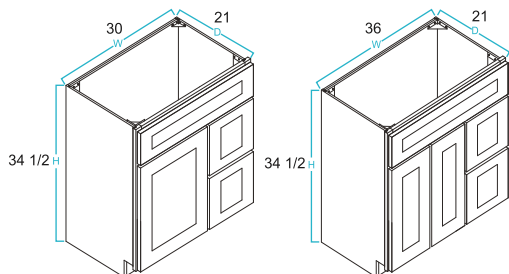

30 - 36" Wide Vanity Sink Base Drawer Cabinets

SKU	Cabinet Doors			False Drawer Head			Operable Drawer Head			Drawer Box		
	W	H	D	W	H	D	W	H	D	W	H	D
V3021D-R	17 1/2	22	7/8	29 1/2	6 3/4	7/8	11 1/2	10 3/4	7/8	8 1/2	7	18
V3021D-L	17 1/2	22	7/8	29 1/2	6 3/4	7/8	11 1/2	10 3/4	7/8	8 1/2	7	18
V3621D-R	11 3/4	22	7/8	35 1/2	6 3/4	7/8	11 1/2	10 3/4	7/8	8 1/2	7	18
V3621D-L	11 3/4	22	7/8	35 1/2	6 3/4	7/8	11 1/2	10 3/4	7/8	8 1/2	7	18

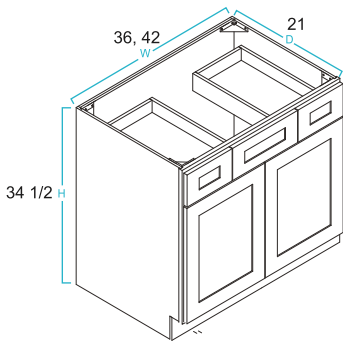

36 - 42" Wide Vanity Base Cabinets												
SKU	Cabinet Doors			False Drawer Head			Operable Drawer Head			Drawer Box		
	W	H	D	W	H	D	W	H	D	W	H	D
VB3621	17 5/8	22	7/8	16 1/2	6 3/4	7/8	9	6 3/4	7/8	6	4	18
VB4221	20 1/2	22	7/8	20 1/2	6 3/4	7/8	10	6 3/4	7/8	7	4	18

*Cabinet box is 21" deep.

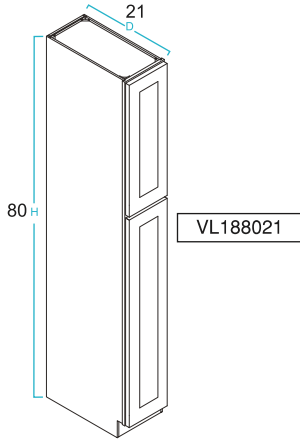

12 - 24" Wide Vanity Drawer Bases										
SKU	Cabinet Box			Top Drawer Head			Top Drawer Box			
	W	H	D	W	H	D	W	H	D	
VDB12-3	12	34 1/2	21	11 1/2	6 3/4	7/8	8 1/2	4	18	
VDB15-3	15	34 1/2	21	14 1/2	6 3/4	7/8	11 1/2	4	18	
VDB18-3	18	34 1/2	21	17 1/2	6 3/4	7/8	14 1/2	4	18	
VDB24-3	24	34 1/2	21	23 1/2	6 3/4	7/8	20 1/2	4	18	

*Bottom drawer heads are the same size.

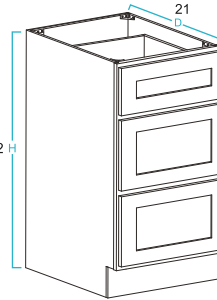

18" Wide Vanity Linen Cabinets										
SKU	Cabinet Box			Top Cabinet Door/Opening			Bottom Cabinet Door			
	W	H	D	W	H	D	W	H	D	
VL188021	18	96	21	17 1/2	28 3/4	7/8	17 1/2	45 1/4	7/8	

vent hood specification

SKU	ANGLE HOOD				
	Dimensions				
	W	H	D	OW	OD
ANGLE HOOD 30"	30	45 5/8	21 5/8	31 3/8	22 1/2
ANGLE HOOD 36"	36	45 5/8	21 5/8	37 3/8	22 1/2

SKU	ARCH HOOD				
	Dimensions				
	W	H	D	OW	OD
ARCH HOOD 30"	30	45 5/8	21 5/8	33	23 1/4
ARCH HOOD 36"	36	45 5/8	21 5/8	39	23 1/4

Only available in the following styles: Charleston Saddle - Charleston Linen - York Driftwood Grey - White Shaker Elite - Natural Unfinished

ANGLE HOOD

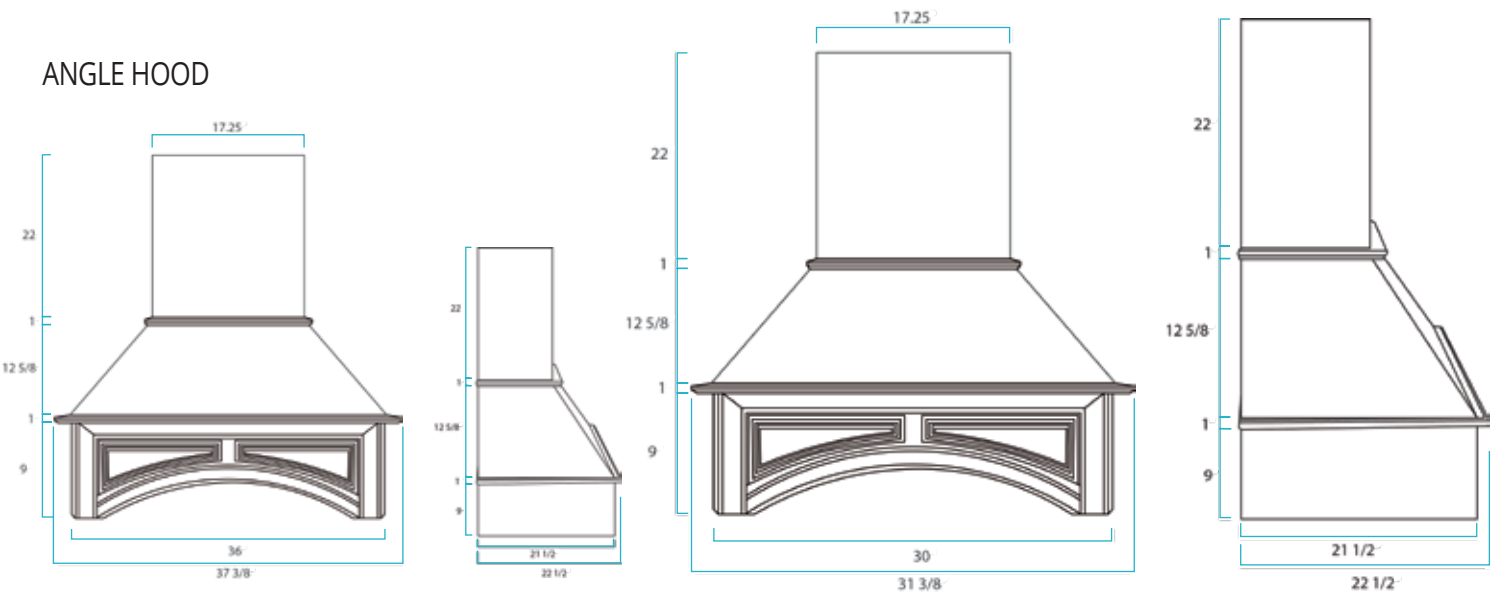

Only available in the following styles: Charleston Saddle - Charleston Linen - York Driftwood Grey - White Shaker Elite - Natural Unfinished

ARCH HOOD

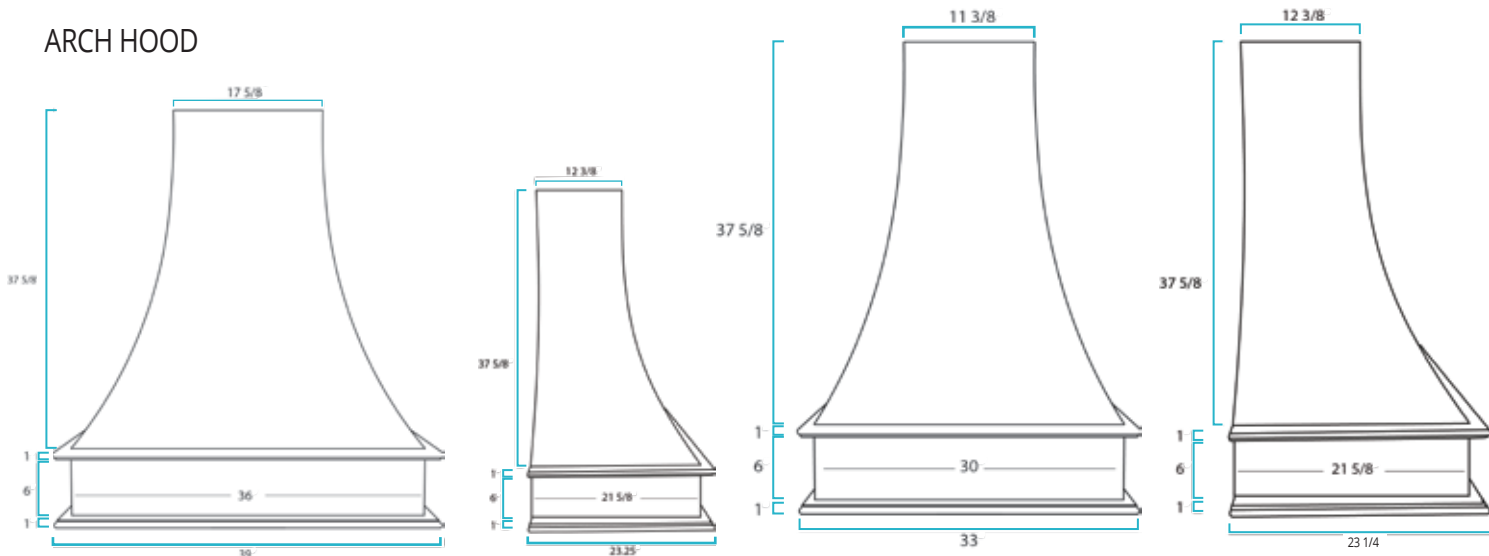

Only available in the following styles: Charleston Saddle - Charleston Linen - York Driftwood Grey - White Shaker Elite - Natural Unfinished

SQUARE HOOD			
SKU	Dimensions		
	W	H	D
SQUARE HOOD 30	30	30	21
SQUARE HOOD 36	36	30	21
SQUARE HOOD 42	42	30	21
SQUARE HOOD 48	48	30	21

Only available in the following styles: Charleston Saddle
Charleston Linen - York Driftwood Grey
White Shaker Elite - Natural Unfinished

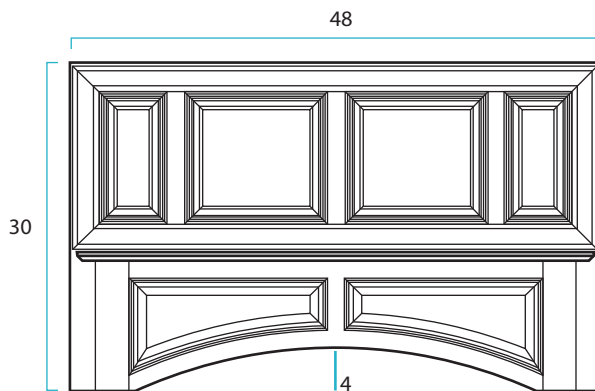
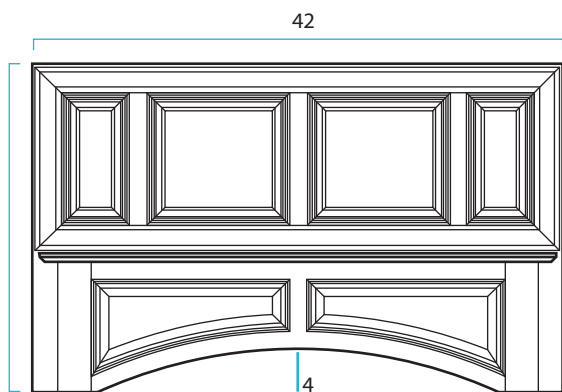
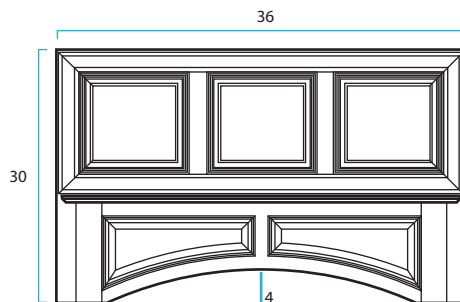
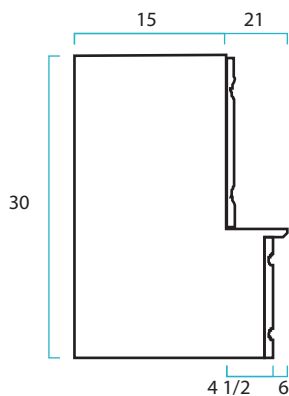

cabinet insert specification

BKS			
SKU	Dimensions		
	W	H	D
B18KS	18	19 5/8	2 1/8

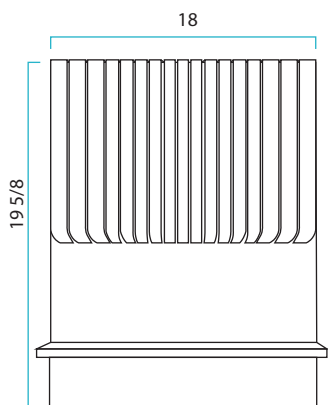

4DPS-30			
SKU	Dimensions		
	W	H	D
4DPS-30	25 1/5	19 5/8	1/2

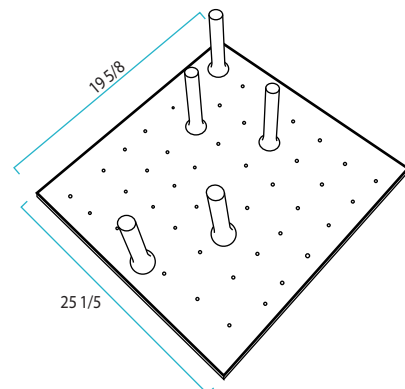

SRD				
SKU	Dimensions			
	W	H	D	
SRD15	15	24	4	
SRD18	18	24	4	

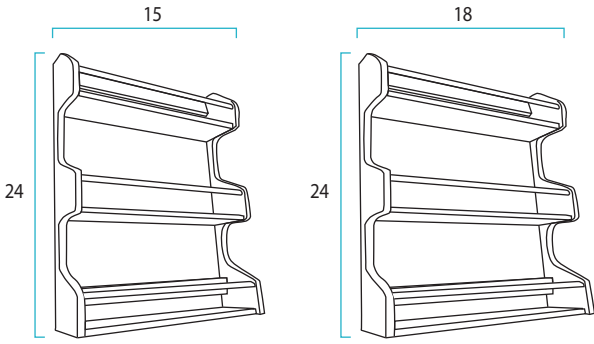

CDI				
SKU	Dimensions			
	W	H	D	
CDI14	13 1/8	2 3/4	19 5/8	
CDI20	19 1/4	2 3/4	19 5/8	

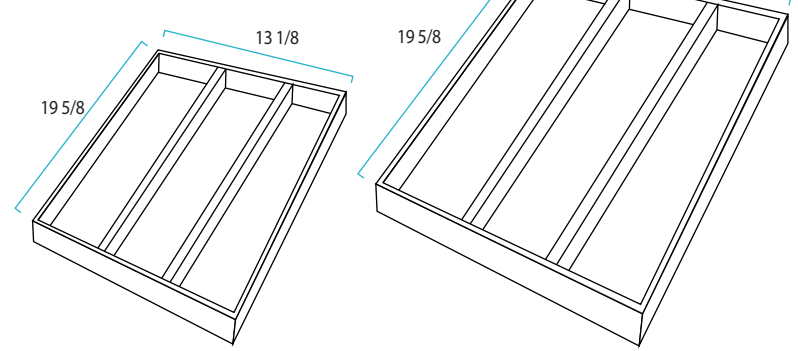

STI				
SKU	Dimensions			
	W	H	D	
STI20	20	19 5/8	1 5/8	

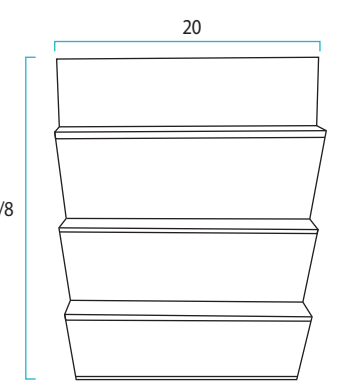

TCCK				
SKU	Dimensions			
	W	H	D	
TCCK	14 5/8	12	21	

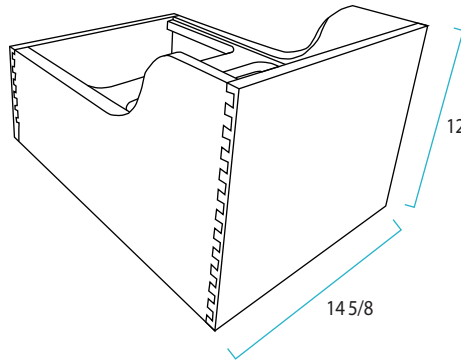

4WTCD				
SKU	Dimensions			
	W	H	D	
4WTCD-18	14 1/2	4	21	
4WTCD-24	20 1/2	4	21	

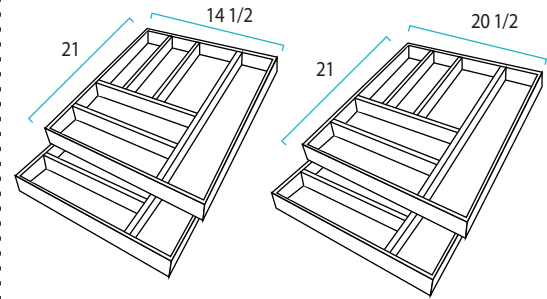

BLIND CORNER BASE CADDY				
SKU	Dimensions			
	W	H	D	
BC-CADDY	15	18 1/2	13 1/8	
PULL OUT DRAWER BOX	22 3/8	13	20 1/2	

*Only fits in BLB/42
Both items sold as a bundle.
One sku for both parts.

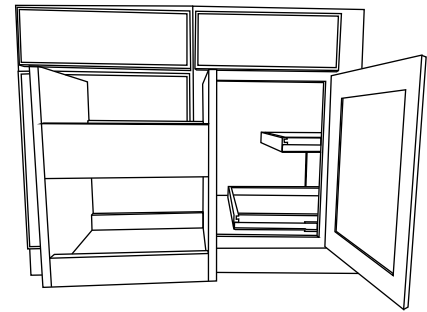
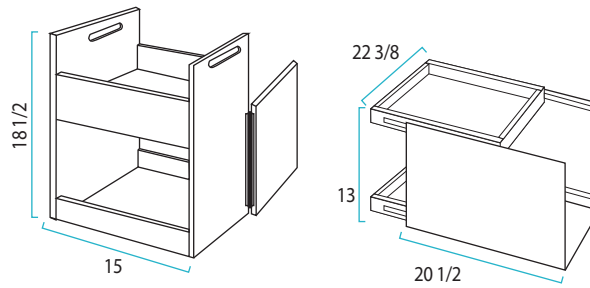

LST		
SKU	Dimensions	
	W	H
LST33	28	2
LST36	32	2

*Fits best in 33in cabinet

*Fits best in 36in cabinet

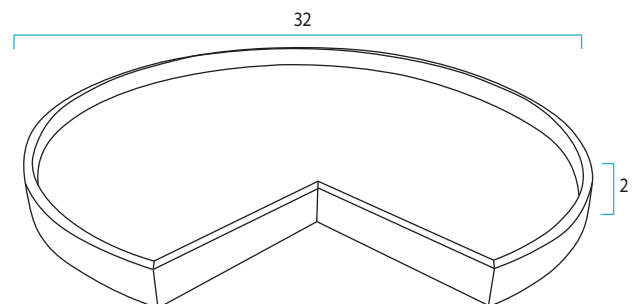
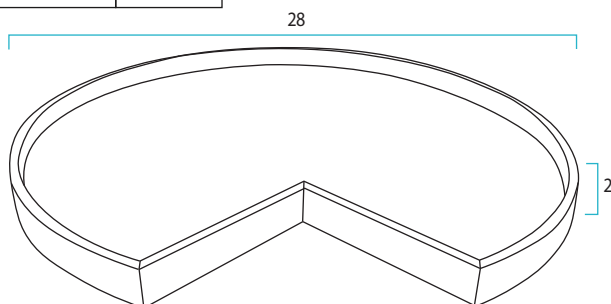

POLST		
SKU	Dimensions	
	W	H
POLST36	35	4

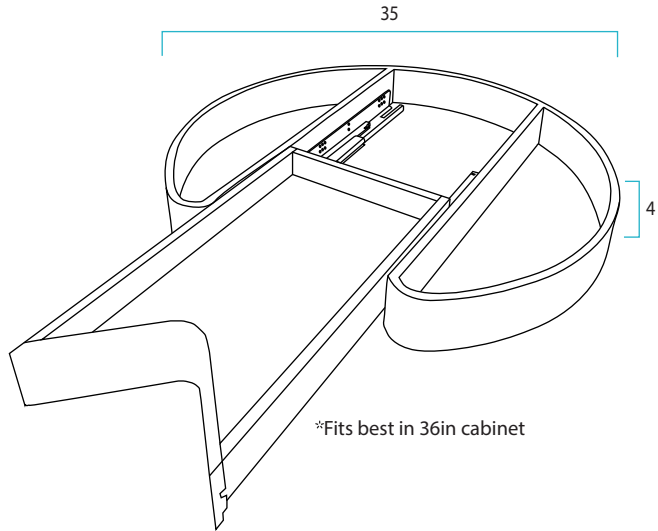

**floating shelf
specification**

SQUARE HOOD				
SKU	Dimensions			
	W	H	D	
FLOATING SHELF 24	24	2 1/2	9 3/4	
FLOATING SHELF 30	36	2 1/2	9 3/4	
FLOATING SHELF 36	42	2 1/2	9 3/4	
FLOATING SHELF 42	48	2 1/2	9 3/4	
FLOATING SHELF 48	48	2 1/2	9 3/4	

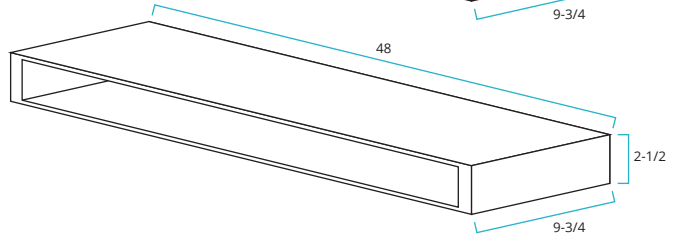
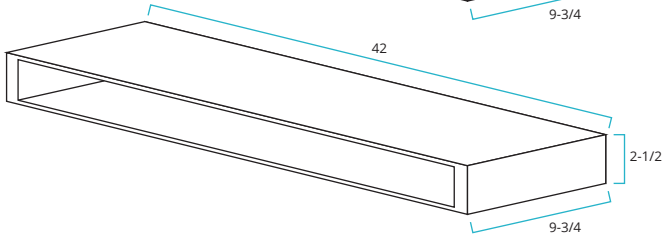
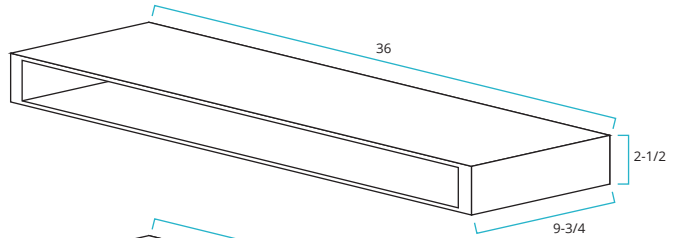
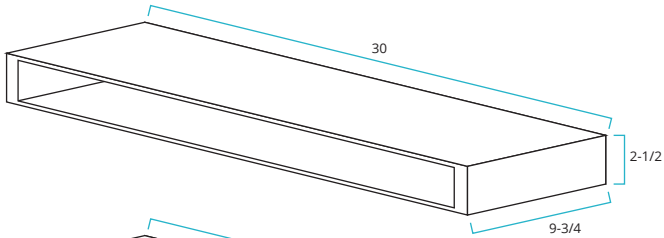
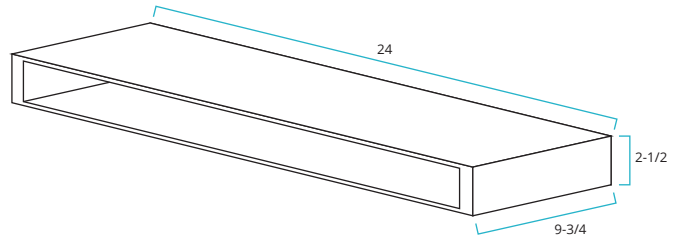

**cabinet lighting
specification**

POWER SUPPLY				
SKU	Dimensions			
	W	H	D	
WF-LED-PSU-JCT-10	3 3/4	1 1/4	3 3/4	
WF-LED-PSU	2 3/8	1	2 3/4	

WF-LED-PSU WF-LED-PSU-JCT-10



CABINET LIGHTING	
SKU	Dimensions
	L
WF-LT50020-5	5
WF-LT50020-8	8
WF-LT50020-11	11
WF-LT50020-14	14
WF-LT50020-17	17
WF-LT50020-20	20
WF-LT50020-23	23
WF-LT50020-26	26
WF-LT50020-29	29
WF-LT50020-32	32
WF-LT50020-35	35
WF-LT0808-7	7
WF-LT0808-25	25
WF-LT0808-31	31
WF-LT0808-37	37

WF-LT50020

LED Lights available in the following lengths

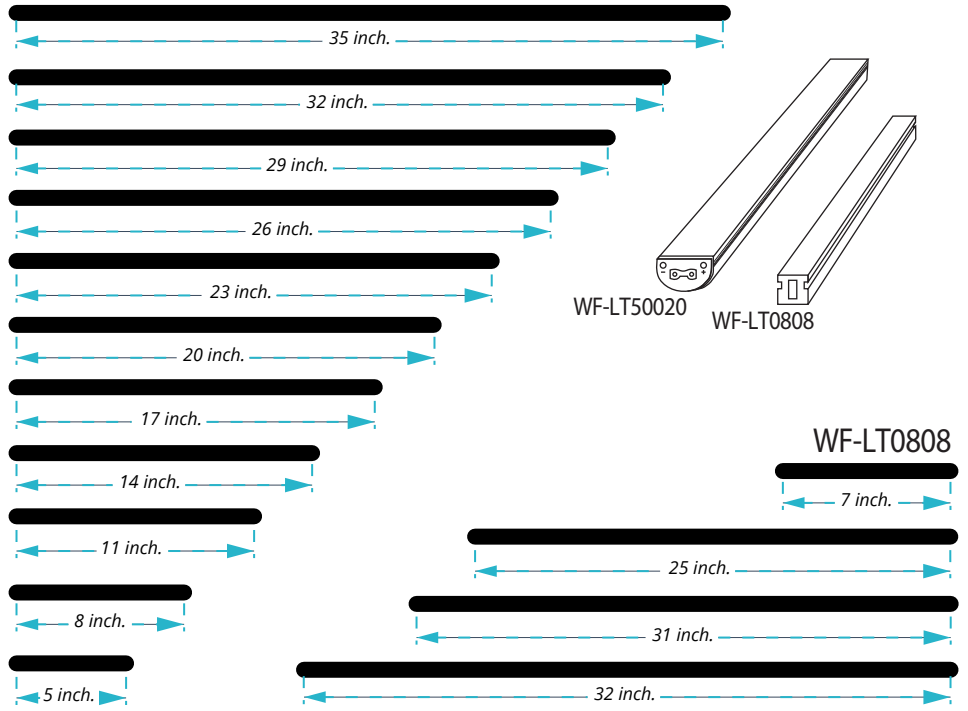

WIRES	
SKU	Dimensions
	L
WF-LT50020-ICC-12	12
WF-LT50020-ICC-40	40
WF-LT50020-ICC-120	120
WF-LT0808-ICC-60	60
WF-LT0808-ICC-120	120
WF-LT50020-PC-60	60
WF-LT50020-PC-120	120

WF-LT50020-ICC-12

WF-LT50020-ICC-40

WF-LT50020-ICC-120

WF-LT0808-ICC-60

WF-LT0808-ICC-120

WF-LT50020-PC-60

WF-LT50020-PC-120

WF-LT50020

CONNECTING WIRES

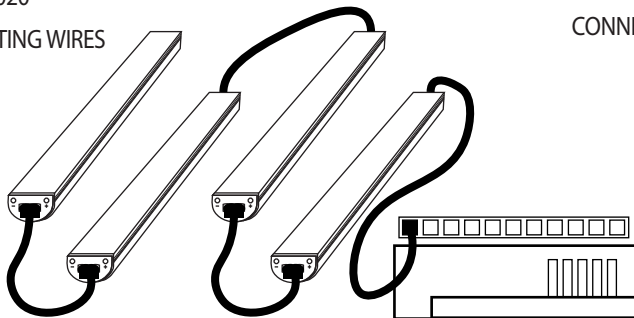

WF-LED-PSU-JCT-10

WF-LT0808

CONNECTING WIRES

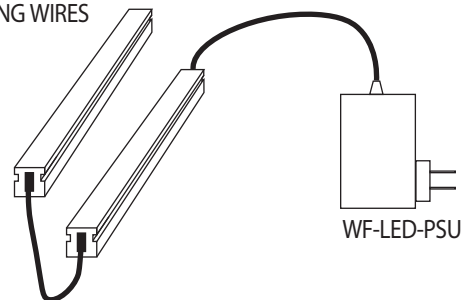

WF-LED-PSU

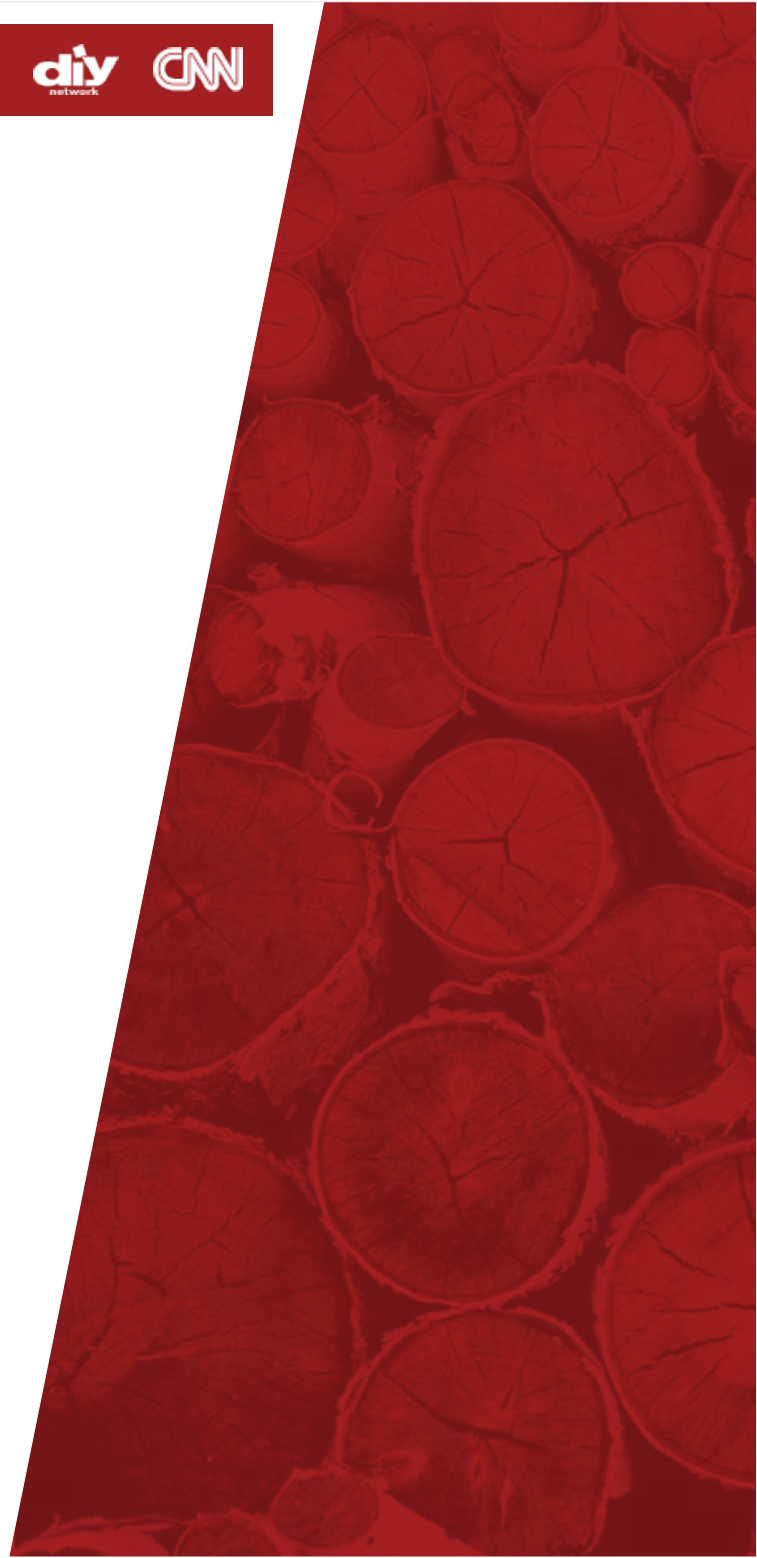

2075 W. Beecher Rd. Adrian, MI 49221
Call: 888-315-6180 Fax: 800-758-7731

www.avacabinetry.com
dealers@avacabinetry.com

